

# Operating Instructions

## SIRAX BT5400

Transducer for Active, Apparent, Reactive Power,  
Phase Angle and Power Factor



 **CAMILLE BAUER**

Camille Bauer Metrawatt AG  
Aargauerstrasse 7  
CH-5610 Wohlen/Switzerland

Tel: +41 56 618 21 11  
Fax: +41 56 618 21 21

info@cbmag.com  
www.camillebauer.com

## Legal information

### Warning notices

In this document warning notices are used, which you have to observe to ensure personal safety and to prevent damage to property. Depending on the degree of danger the following symbols are used:



If the warning notice is not followed death or severe personal injury **will** result.



If the warning notice is not followed damage to property or severe personal injury **may** result.



If the warning notice is not followed the device **may** be damaged or **may** not fulfill the expected functionality.

### Qualified personnel

The product described in this document may be handled by personnel only, which is qualified for the respective task. Qualified personnel have the training and experience to identify risks and potential hazards when working with the product. Qualified personnel are also able to understand and follow the given safety and warning notices.

### Intended use

The product described in this document may be used only for the application specified. The maximum electrical supply data and ambient conditions specified in the technical data section must be adhered. For the perfect and safe operation of the device proper transport and storage as well as professional assembly, installation, handling and maintenance are required.

### Disclaimer of liability

The content of this document has been reviewed to ensure correctness. Nevertheless it may contain errors or inconsistencies and we cannot guarantee completeness and correctness. This is especially true for different language versions of this document. This document is regularly reviewed and updated. Necessary corrections will be included in subsequent version and are available via our webpage <http://www.camillebauer.com>.

### Feedback

If you detect errors in this document or if there is necessary information missing, please inform us via e-mail to: [customer-support@camillebauer.com](mailto:customer-support@camillebauer.com)

# Table of content

<b>1. Introduction</b>	<b>4</b>
1.1 Purpose of this document	4
1.2 Scope of supply	4
1.3 Further documents	4
<b>2. Safety notes</b>	<b>4</b>
<b>3. Device overview</b>	<b>5</b>
<b>4. Mechanical mounting</b>	<b>5</b>
4.1 Mounting	5
4.2 Demounting of the device	5
<b>5. Electrical connections</b>	<b>6</b>
5.1 General safety notes	6
5.2 Cross sections and tightening torques	6
5.3 Inputs	6
5.4 Power supply	6
5.5 Connection Diagram	7
5.6 Modbus interface RS485	8
<b>6. Commissioning</b>	<b>8</b>
6.1 Operating the device	9
6.2 LED indication	9
6.3 Input and output screens	9
<b>7. Programming</b>	<b>10</b>
7.1 Programming via Front LCD & Two keys	10
7.1.1 Password Protection	10
7.1.1.1 Password Verification	10
7.1.1.2 Editing Existing Password	11
7.1.2 Transducer Type Selection	12
7.1.3 System Type Selection	12
7.1.4 Output Type Selection	12
7.1.4.1 Output 1 Type Selection	12
7.1.4.2 Output 2 Type Selection	13
7.1.5 Potential Transformer Parameter Setting	13
7.1.5.1 Potential Transformer primary value	13
7.1.5.2 Potential Transformer Secondary Value	14
7.1.6 Current Transformer Parameter Setting	15
7.1.6.1 Current Transformer Primary Value	15
7.1.6.2 Current Transformer Secondary Value	16
7.1.7 Communication Parameter Setting	17
7.1.7.1 Address Setting	17
7.1.7.2 RS 485 Baud rate	17
7.1.7.3 RS 485 Parity Selection	18
7.1.8 Input Characteristics Setting	18
7.1.8.1 End value of Input	18
7.1.8.2 Start value of Input	19
7.1.8.3 Elbow Function selection	20
7.1.8.4 Elbow value of Input	20
7.1.9 Output Characteristics Setting	21
7.1.9.1 Output 1 Characteristics Setting	21
7.1.9.1.1 End value of output 1	21
7.1.9.1.2 Start value of output 1	22
7.1.9.1.3 Elbow value of output 1	23
7.1.9.2 Output 2 Characteristics Setting	24
7.1.9.2.1 End value of output 2	24
7.1.9.2.2 Start value of output 2	24
7.1.9.2.3 Elbow value of output 2	25
7.1.10 Mode Selection	26
<b>8. Phasor Diagram</b>	<b>27</b>
<b>9. Programming via the programming connection and the PRKAB5000 programming cable</b>	<b>28</b>
9.1. Programming via the RS485 (Modbus) interface	28
9.2. DIP Switch Setting for Output	28
<b>10. Service, maintenance and disposal</b>	<b>29</b>
10.1 Repair work and modifications	29
10.2 Calibration and new adjustment	29
10.3 Cleaning	29
10.4 Disposal	29
10.5 Return	29
<b>11. Technical data</b>	<b>30</b>
<b>12. Dimensional drawings</b>	<b>32</b>
<b>13. Interface Definition Modbus RTU</b>	<b>33</b>
13.1 Modbus functions	33
13.2 Datatyp	33
13.3 Modbus register	34

# 1. Introduction

## 1.1 Purpose of this document

This document describes the universal measurement device SIRAX BT5400. It is intended to be used by:

- Installation personnel and commissioning engineers
- Service and maintenance personnel
- Planners

### Scope

This handbook is valid for all hardware versions of the BT5400. Some of the functions described in this document are available only, if the necessary optional components are included in the device.

### Required knowledge

A general knowledge in the field of electrical engineering is required. For assembly and installation of the device knowledge of applicable national safety regulations and installation standard is required.

## 1.2 Scope of supply

- Measurement device SIRAX BT5400
- Safety instructions (multiple languages)

## 1.3 Further documents

The following documents are provided electronically via [www.camillebauer.com](http://www.camillebauer.com):

- Safety instructions SIRAX BT5400
- Operating Instructions SIRAX BT5400
- Product Brochure SIRAX Transducers series

# 2. Safety notes



Device may only be disposed in a professional manner!



The installation and commissioning should only be carried out by trained personnel.

Check the following points before commissioning:

- that the maximum values for all the connections are not exceeded, see „Technical data“ section,
- that the connection wires are not damaged, and that they are not live during wiring,
- that the power flow direction and the phase rotation are correct.

The instrument must be taken out of service if safe operation is no longer possible (e.g. visible damage). In this case, all the connections must be switched off. The instrument must be returned to the factory or to an authorized service dealer.

It is forbidden to open the housing and to make modifications to the instrument. The instrument is not equipped with an integrated circuit breaker. During installation check that a labeled switch is installed and that it can easily be reached by the operators.

Unauthorized repair or alteration of the unit invalidates the warranty.

### 3. Device overview

The SIRAX BT5400 is a transducer for a configurable measurement quantity (active, reactive, apparent power, phase angle or power factor) of a single phase or three-phase power system. The measurement is available via display, Modbus interface and proportionally on two analog DC current or voltage outputs. Extended information may be read via the Modbus interface (see chapter 13).

### 4. Mechanical mounting

The SIRAX BT5400 is designed for panel mounting.



Please ensure that the operating temperature limits are not exceeded when determining the place of mounting (place of measurement): **0 ... +45 °C**

#### 4.1 Mounting

Dimensional drawing BT5400: See section 12

Any mounting position is possible. Device may be clipped onto a top-hat rail according EN 50022.

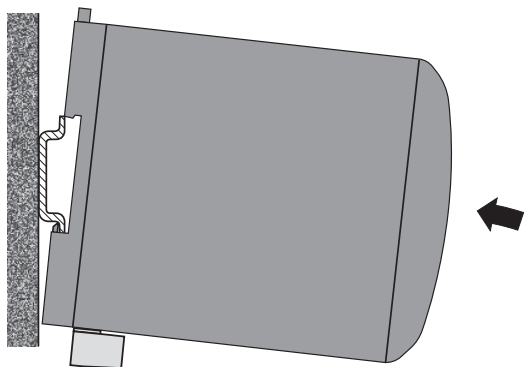

#### 4.2 Demounting of the device

Disassembly of the device requires that all connected wires be without current. First, remove all push terminals and the wires of the current and voltage inputs. Ensure that possible current transformers are short-circuited before the current connections on the device are opened. Release the transducer from a top-hat rail.

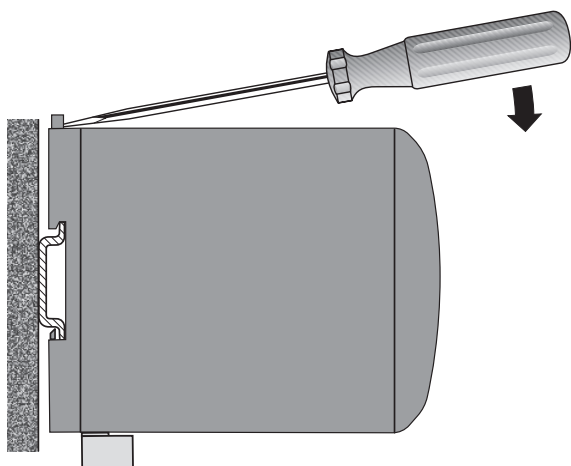

## 5. Electrical connections



Ensure under all circumstances that the leads are free of potential when connecting them!

### 5.1 General safety notes



**Please observe that the data on the type plate must be adhered to!**

The national provisions have to be observed in the installation and material selection of electric lines!

Symbol	Meaning
	Device may only be disposed of in a professional manner!
	Double insulation, device of protection class 2
CAT III	Measurement category CAT III for voltage inputs and power supply
	CE conformity mark. The device fulfills the requirements of the applicable EC directives. See declaration of conformity.
	Caution! General hazard point. Read the operating instructions.
	Attention: Danger to life!
	Please note

### 5.2 Cross sections and tightening torques

#### Terminals 1 ... 18

Single wire:  $\leq 4,0\text{mm}^2$  or multiwire with end splices:  $2 \times 2,5\text{mm}^2$

Torque: 0.5 ... 0.6Nm rsp. 4.42 ... 5.31 lbf in

#### Terminal A, B, G

Single wire:  $\leq 1,5\text{mm}^2$  or multiwire with end splices:  $2 \times 0,5\text{mm}^2$

Torque: max. 0.5 Nm rsp. 4.42 lbf in

### 5.3 Inputs



All voltage measurement inputs must originate at circuit breakers or fuses rated by 1 Amps. This does not apply to the neutral connector. You have to provide a method for manually removing power from the device, such as a clearly labeled circuit breaker or a fused disconnect switch.

When using **voltage transformers** you have to ensure that their secondary connections never will be short-circuited.

### 5.4 Power supply



A marked and easily accessible current limiting switch has to be arranged in the vicinity of the device for turning off the power supply. Fusing should be 10 Amps or less and must be rated for the available voltage and fault current.

## 5.5 Connection Diagram

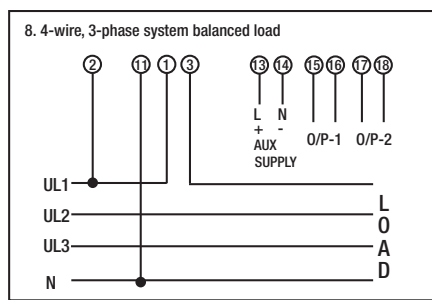
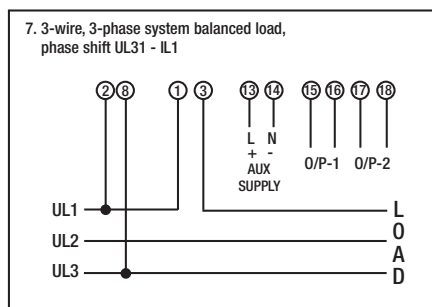
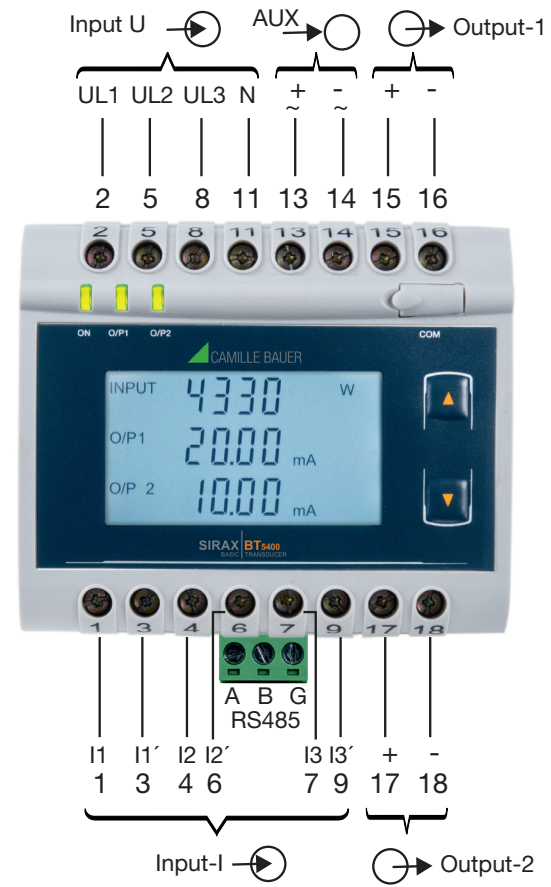
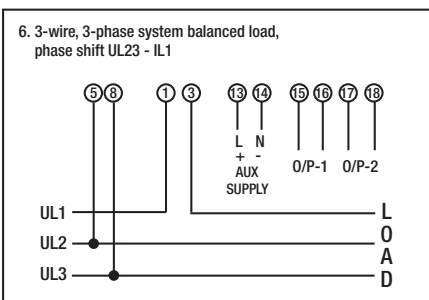
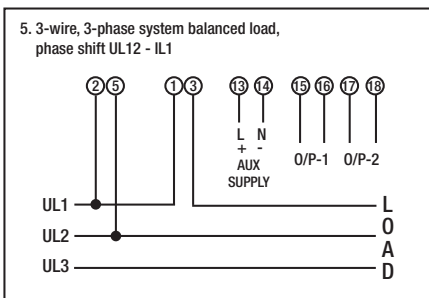
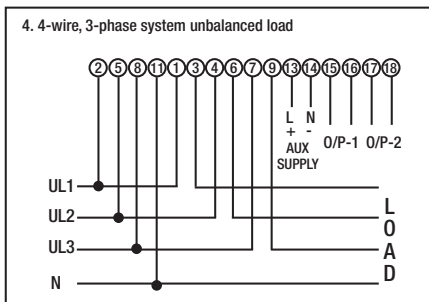
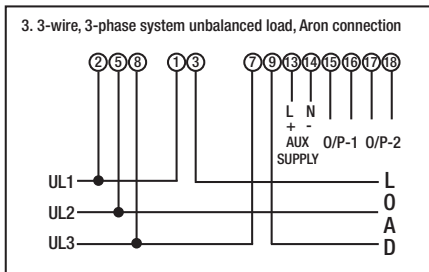
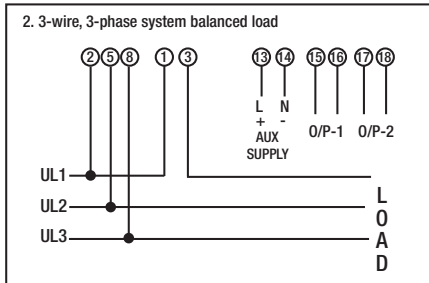
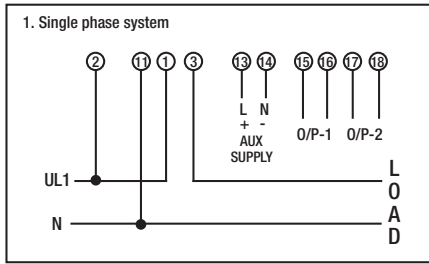

## 5.6 Modbus interface RS485

Via the optional Modbus interface measurement data may be provided for a superior system.

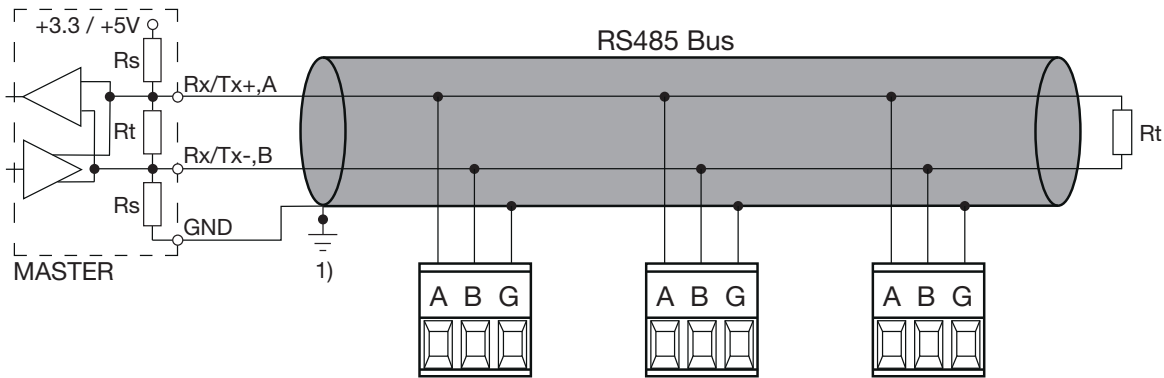

1) One ground connection only. This is possibly made within the master (PC).

Rt: Termination resistors: 120  $\Omega$  each for long cables (> approx. 10 m)

Rs: Bus supply resistors, 390  $\Omega$  each

The signal wires (A, B) have to be twisted. G can be connected via a wire or via the cable screen. In disturbed environments shielded cables must be used. To avoid the possibility of loop currents, an Earth connection should be made at one point on the bus. Supply resistors (Rs) have to be present in bus master (PC) interface. Stubs should be avoided when connecting the devices. A pure daisy chain network is ideal.

You may connect up to 32 Modbus devices to the bus. A proper operation requires that all devices connected to the bus have equal communication settings (baud rate, transmission format) and unique Modbus addresses.

The bus system is operated half duplex and may be extended to a maximum length of 1200 m without repeater.

## 6. Commissioning



Before commissioning you have to check if the connection data of the device match the data of the plant. If so, you can start to put the device into operation by switching on the power supply and the measurement inputs.

<b>SIRAX BT5400</b> TRMS Power Transducer			
ORDER CODE: 175316 SR No.: 16/02/0001 OPTION: RS485, 2 Output INPUT RANGE: 0...4330W		CAT III, 300V	
	INPUT VOLTAGE 0...500 VLL, 50/60Hz		
	INPUT CURRENT 0...5A ~		
	AUX: 60...300V ~, 50/60Hz, 10VA		
	Output 1: 4...20mA, Rext < 750Ohm		
	Output 2: 0...10V, Rext ≥ 5kOhm		
Camille Bauer Metrawatt AG Aargauerstrasse 7 / 5610 Wohlen / Switzerland			

Label version



## 6.1 Operating the device

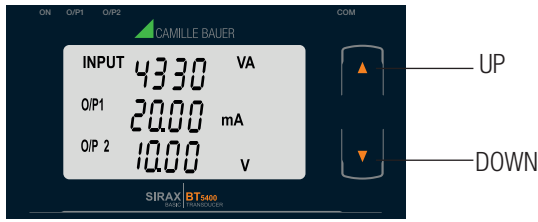

SIRAX BT5400 can be configured and programmed at site for the following: PT Primary, PT Secondary, CT Primary, CT Secondary, Input Characteristics (i.e start, end and elbow value of Input) and Output Characteristics (i.e Voltage or Current and start, end and elbow Value of outputs.) The front panel has two push buttons through which the user can enter into programming mode and can configure the transducer.

Operation is performed by means of 2 keys:

2 keys “ UP” and “ DOWN” for navigation and for the selection of values.

## 6.2 LED indication

LED	LED OPERATING CONDITION	LED OPERATING STATUS
ON	Aux. Supply healthy condition	Green LED continuous ON
O/P 1	Output 1 voltage	Green LED continuous ON
	Output 1 current	Red LED continuous ON
O/P 2	Output 2 voltage	Green LED continuous ON
	Output 2 current	Red LED continuous ON

Table 1: Measured parameters

Measured parameters	Unit of Measurement
Active Power	W
Reactive Power	VAr
Apparent Power	VA
Power Factor	—
Phase Angle	°(DEG)

## 6.3 Input and output screens

In normal operation the user is presented with display test screen followed by version screen to one of the output screen.

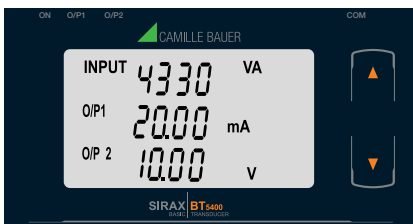

For Apparent Power Transducer: Input Apparent Power, Output 1 as Current or Voltage  
Output 2 as Current or Voltage

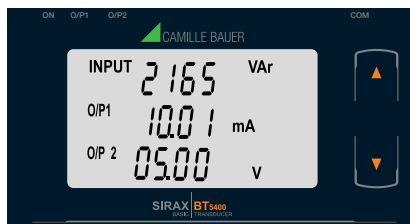

For Reactive Power Transducer, Input Reactive Power, Output 1 as Current or Voltage  
Output 2 as Current or Voltage

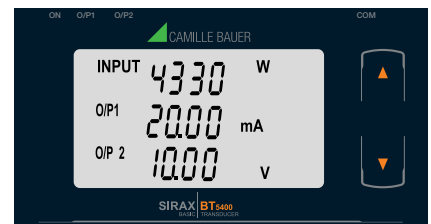

For Active Power Transducer, Input Active Power, Output 1 as Current or Voltage  
Output 2 as Current or Voltage

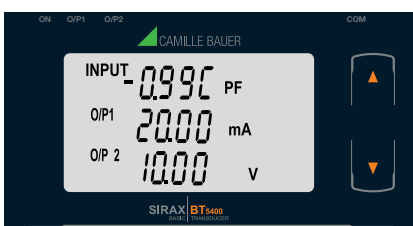

For Power Factor Transducer Input Power Factor, Output 1 as Current or Voltage  
Output 2 as Current or Voltage

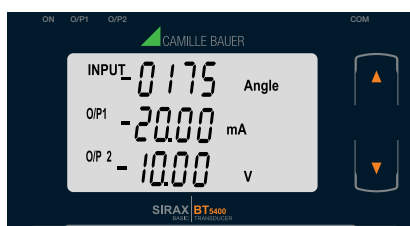

For Phase Angle Transducer Input Phase Angle, Output 1 as Current or Voltage  
Output 2 as Current or Voltage

## 7. Programming

Programming of transducer can be done in three ways:

- 1) Programming via Front LCD & two keys.
- 2) Programming Via Programming port available at front of Transducers using optional PRKAB601 Adapter.
- 3) Programming via optional RS485 (MODBUS) communication port.

### 7.1 Programming via Front LCD & Two keys

The following sections comprise step by step procedures for configuring the SIRAX BT5400 for individual user requirements.

To access the set-UP screens, press and hold the “ DOWN” and “ UP” Key simultaneously for 5 seconds. This will take the User to the Password screen.

#### 7.1.1 Password Protection

##### 7.1.1.1 Password Verification



Password protection can be enabled to prevent unauthorised access to set-up screens, by default password protection is not enabled.

Password protection is enabled by selecting a four digit number other than 0000, setting a password of 0000 disables the password protection.



Enter Password, prompt for first digit. (\*Denotes that digit will be flashing).

Pressing the “ Down” key will scroll the value of the first digit from 0 to 9 and the value will roll back again to 0.

Pressing the “ Up” key will advance the operation to next digit and set the first digit. In the special case where the Password is “0000” pressing the “ Down” key when prompted for the First digit will advance to the “Password Confirmation” mode.



After first digit gets entered, it will prompt for second digit. (\*Denotes that digit will be flashing).

Pressing the “ Down” key will scroll the value of the second digit from 0 to 9 and the value will roll back again to 0.

Pressing the “ Up” key will advance the Operation to the next digit and set the second digit.



After, second digit gets entered, it will prompt for third digit. (\*Denotes that digit will be flashing).

Pressing the “ Down” key will scroll the value of the third digit from 0 to 9 and the value will roll back again to 0.

Pressing the “ Up” key will advance the Operation to the next digit and set the third digit.



After, third digit get entered, it will prompt for fourth digit. (\*Denotes that digit will be flashing).

Pressing the “ Down” key will scroll the value of the fourth digit from 0 to 9 and the value will roll back again to 0.

Pressing the “ Up” key will advance the Operation to the next digit and set the fourth digit.



#### Confirmation of Password

Pressing “ Down” key will enter to the “ Password edit ” mode. (section 7.1.1.2)

Pressing the “ Up” key will advance to the Transducer Type selection (section 7.1.2).

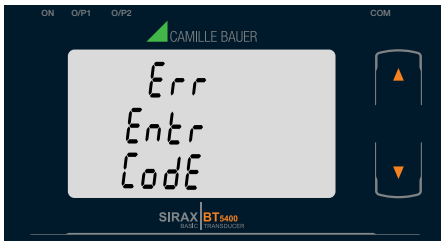

### Password Incorrect.

This screen is displayed when the unit has not accepted the Password entered.

Pressing the " ⬇️ Down" key will re-enter to the "Enter Password" entry stage.

Pressing the " ⬆️ Up" key will exit the setup menu.

### 7.1.1.2 Editing Existing Password



#### Editing Existing Password

(\*Denotes that digit will be flashing).

Pressing the " ⬇️ Down" key will scroll the value of the first digit from 0 to 9 and the value will roll back again to 0.

Pressing the " ⬆️ Up" key will advance the operation to the next digit and set the first digit, in this case to "4"



After first digit gets entered, it will prompt for second digit.

(\*Denotes that digit will be flashing). Pressing the " ⬇️ Down" key will scroll the value of the second digit from 0 to 9 and the value will roll back again to 0.

Pressing the " ⬆️ Up" key will advance the operation to the next digit and set the second digit, in this case to "1"



After second digit gets entered, it will prompt for third digit.

(\*Denotes that digit will be flashing).

Pressing the " ⬇️ Down" key will scroll the value of the third digit from 0 to 9 and the value will roll back again to 0.

Pressing the " ⬆️ Up" key will advance the operation to the next digit and set third digit, in this case to "4".



After third digit gets entered, it will prompt for fourth digit.

(\* Denotes that digit will be flashing).

Pressing the " ⬇️ Down" key will scroll the value of the fourth digit from 0 to 9 and the value will roll back again to 0.

Pressing the " ⬆️ Up" key will advance the operation to the " Password Confirmation" mode and set the fourth digit, in this case to "1".



#### Confirmation of Password

Pressing the " ⬇️ Down" key will re-enter to the " Password edit " mode.

Pressing the " ⬆️ Up" key will confirm Password and advance to the Transducer Type Selection (section 7.1.2).

### 7.1.2 Transducer Type Selection

This screen allows the user to set the transducer type as Active, Reactive, Apparent Power, Phase angle or Power Factor.



Pressing the “ Down” key display will show “Transducer type edit” mode and scroll between

- ACT:** Active Power
- APP:** Apparent Power
- rEA:** Reactive Power
- PF:** Power Factor
- PHA:** Phase Angle

and will roll back again to **ACT** (Parameters are flashing).

Pressing “ Up” key will confirm the selected type and advance to the System type selection (section 7.1.3).

#### Confirmation of Transducer Type

Pressing “ Down” key will re-enter into “Transducer type edit” mode.

Pressing the “ Up” key will set the Transducer type and advance to the System type Selection (section 7.1.3).

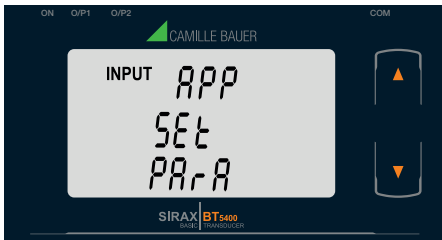

### 7.1.3 System Type Selection

This screen allows the user to set System Type.



Pressing the “ Down” key will enter into the “System Type edit” mode. For Active / Apparent / Reactive Power Transducer, System type will scroll between

- 1PH2:** Single-Phase AC Network
- 3PH4 bAL:** 3-Phase 4-Wire balanced load
- 3PH3 bAL:** 3-Phase 3-Wire balanced load
- 3PH3 Ubal:** 3-Phase 3-Wire Unbalanced load
- 3PH4 Ubal:** 3-Phase 4-Wire Unbalanced load

For Phase angle and Power factor Transducer networks supported are

- UL 12 bAL:** 3-Phase 3-Wire balanced load
- UL 23 bAL:** 3-Phase 3-Wire balanced load
- UL 31 bAL:** 3-Phase 3-Wire balanced load
- 3PH4 bAL:** 3-Phase 4-Wire balanced load
- 3PH3 bAL:** 3-Phase 3-Wire balanced load
- 1PH2:** Single-Phase AC Network

Pressing “ Up” key accepts the present value and advance to the to the Output type selection (section 7.1.4).

#### Confirmation of System Type

Pressing “ Down” key will re-enter into “System Type edit” mode.

Pressing the “ Up” key will set the value and advance to the Output type selection (section 7.1.4).



### 7.1.4 Output Type Selection

#### 7.1.4.1 Output 1 Type Selection

This screen allows the user to set the output 1 type as Voltage or Current.

Pressing the “ Down” key will enter the transducer into “output 1 type edit” mode and scroll between voltage and current.

Pressing “ Up” key will confirm the present type for Output 1 and advance to the Output 2 type selection(section 7.1.4.2).



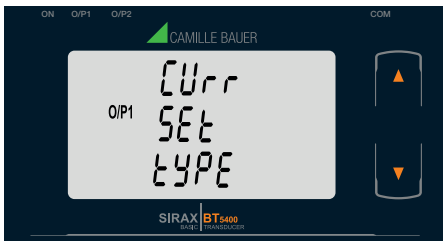

### Confirmation of Output 1 Type

Pressing “**⬇** Down” key will re-enter into “Output 1 type edit” mode.

Pressing the “**⬆** Up” key will set the type and advance to the Output 2 type selection (section 7.1.4.2).

### 7.1.4.2 Output 2 Type Selection

This screen allows the user to set the output 2 type as Voltage or Current for dual output transducer.



Pressing the “**⬇** Down” key will enter the “output 2 type edit” mode and scroll between voltage and current.

Pressing “**⬆** Up” key accepts the present type for Output 2 and advance to the Potential Transformer parameter selection (section 7.1.5).



### Confirmation of Output 2 Type

Pressing “**⬇** Down” key will re-enter into “Output 2 type edit” mode.

Pressing the “**⬆** Up” key will set the type and advance to the Potential Transformer parameter selection (section 7.1.5).

**Note: After changing Output type switch off the Transducer and change DIP switch setting. If DIP switch setting is done before changing the output Type through Display. Then change the Output type through Display and switch off the Transducer and then switch ON. (Section 7.3.1)**

## 7.1.5 Potential Transformer Parameter Setting

### 7.1.5.1 Potential Transformer primary value

This screen allows the user to set the PT Primary value from 100V to 692.8 KVL-L with consideration that presently written PT Primary value with the previously set CT Primary value would not result in maximum power of greater than 1000 MVA per phase.

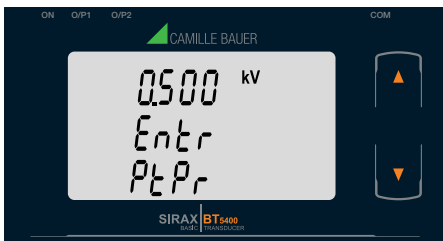

Pressing the “**⬇** Down” key will enter into the “PT Primary value edit” mode.

Pressing “**⬆** Up” key will confirm the present value as PT Primary and advance to the PT secondary value (Section 7.1.5.2).

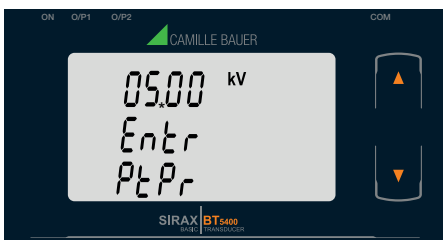

### Editing Existing PT Primary value

(\*Denotes that decimal point will be flashing).

Pressing the “**⬇** Down” key will scroll the decimal point to the next position.

Pressing the “**⬆** Up” key will confirm the decimal point position and advance the operation to set the first digit.



(\*Denotes that digit will be flashing).

Pressing the “**⬇** Down” key will scroll the value of the first digit from 0 to 9, and the value will roll back again to 0.

Pressing the “**⬆** Up” key will advance the operation to the next digit and set the first digit, in this case to “0”.

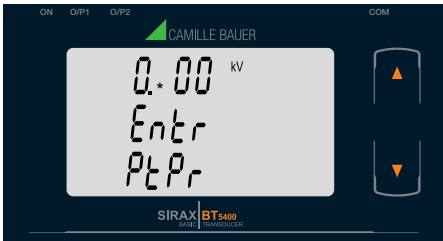

After first digit gets entered, it will prompt for second digit.  
(\*Denotes that digit will be flashing).

Pressing the “ Down” key will scroll the value of the second digit from 0 to 9 and the value will roll back again to 0 or it will get restricted depending on first digit set.

Pressing the “ Up” key will advance the operation to the next digit and set the second digit, in this case to “0”.



After second digit gets entered, it will prompt for third digit.  
(\*Denotes that digit will be flashing).

Pressing the “ Down” key will scroll the value of the third digit from 0 to 9 and the value will roll back again to 0 or it will get restricted depending on second digit set.

Pressing the “ Up” key will advance the operation to the next digit and set the third digit, in this case to “0”.

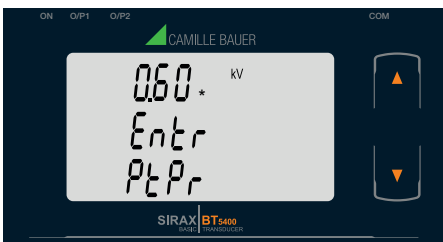

After third digit gets entered, it will prompt for fourth digit.  
(\*Denotes that digit will be flashing).

Pressing the “ Down” key will scroll the value of the fourth digit from 0 to 9 and the value will roll back again to 0 or it will get restricted depending on third digit set.

Pressing the “ Up” key will advance the operation to the “PT Primary value confirmation” and set the fourth digit, in this case to “0”.

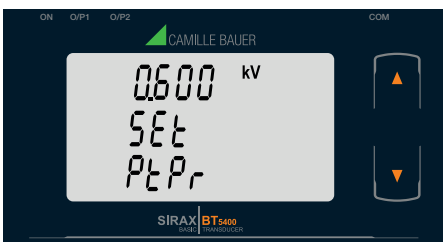

#### Confirmation of PT Primary value

Pressing the “ Down” key will re-enter to the “PT Primary value edit” mode.

Pressing the “ Up” key will confirm PT Primary value and advance to the PT Secondary selection (section 7.1.5.2).

### 7.1.5.2 Potential Transformer Secondary Value

This screen allows the user to set the PT Secondary value from 100 to 500VLL.



Pressing the “ Down” key will enter into the “PT Secondary value edit” mode.

Pressing the “ Up” key will confirm the present value as PT Secondary and advance to the Current Transformer Parameter Setting (section 7.1.6).



#### Editing Existing PT Secondary value

(\*Denotes that digit will be flashing). First Digit is always zero.

Pressing the “ Down” key will scroll the value of the Second digit from 1 to 5 and the value will roll back again to 1.

Pressing the “ Up” key will advance the operation to the next digit and set the second digit, in this case to “3”.



After second digit gets entered ,it will prompt for third digit.  
(\*Denotes that digit will be flashing)

Pressing the “ Down” key will scroll the value of the third digit from 0 to 9 and the value will roll back again to 0 or it will get restricted depending on second digit set.

Pressing the “ Up” key will advance the operation to the next digit and set the third digit, in this case to “0”.



After third digit gets entered ,it will prompt for fourth digit.  
(\*Denotes that digit will be flashing)

Pressing the “ Down” key will scroll the value of the fourth digit from 0 to 9 and the value will roll back again to 0 or it will get restricted depending on second digit set.

Pressing the “ Up” key will advance to “PT secondary value confirmation” mode and set the fourth digit, in this case to “0”.

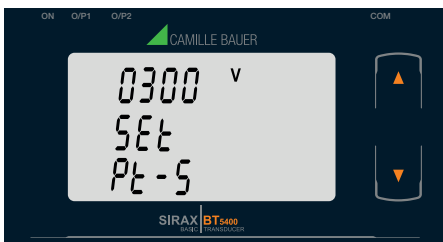

### Confirmation of PT Secondary value

Pressing the “ Down” key will re-enter into “PT Secondary value edit” mode.

Pressing the “ Up” key will confirm PT Secondary value and advance to the Current Transformer Parameter Selection (section 7.1.6).

## 7.1.6 Current Transformer Parameter Setting

### 7.1.6.1 Current Transformer Primary Value

This screen allows the user to set the CT Primary value from 1 to 9999 A with consideration that presently written CT Primary value with the previously set PT Primary value would not result in maximum power of greater than 1000 MVA per phase.



Pressing the “ Down” key will enter the transducer into “CT Primary value edit” mode.

Pressing “ Up” key will confirm the present value as CT Primary and advance to the CT secondary selection (section 7.1.6.2).



### Editing Existing CT Primary Value

(\*Denotes that digit will be flashing).

Pressing the “ Down” key will scroll the value of the first digit from 0 to 9 and the value will roll back again to 0.

Pressing the “ Up” key will advance the operation to the next digit and set the first digit, in this case to “0”.

Pressing the “ Up” key will advance the operation to the next digit and set the first digit, in this case to “0”.



After, first digit gets entered, it will prompt for second digit.  
(\*Denotes that digit will be flashing).

Pressing the “ Down” key will scroll the value of the second digit from 0 to 9 and the value will roll back again to 0 or it will get restricted depending on first digit set. Pressing the “ Up” key will advance the operation to the next digit and set the second digit, in this case to “0”.



After second digit gets entered, it will prompt for third digit.  
(\*Denotes that digit will be flashing).

Pressing the “**Down**” key will scroll the value of the third digit from 0 to 9 and the value will roll back again to 0 or it will get restricted depending on second digit set.

Pressing the “**Up**” key will advance the operation to the next digit and set the third digit, in this case to “0”.



After third digit gets entered, it will prompt for fourth digit.  
(\*Denotes that digit will be flashing).

Pressing the “**Down**” key will scroll the value of the fourth digit from 0 to 9 and the value will roll back again to 0 or it will get restricted depending on third digit set.

Pressing the “**Up**” key will advance the operation to the “CT primary value Confirmation” and set the fourth digit, in this case to “5”.

**Example:** If PT primary value is set as 692.8 KVL-L (Max value) then CT primary Will restricted to 1736 A. The “Maximum power” restriction of 1000 MVA refers to 120 % Nominal current & 120 % nominal voltage, i.e.694.4 MVA Nominal power per phase.



Confirmation of CT Primary value . Pressing the “**Down**” key will re-enter to the “ CT Primary value edit” mode.

Pressing the “**Up**” key will confirm CT Primary value and advance to the CT secondary setting (section 7.1.6.2).

### 7.1.6.2 Current Transformer Secondary Value

This screen allows the user to set the CT Secondary value from 1 to 5A.

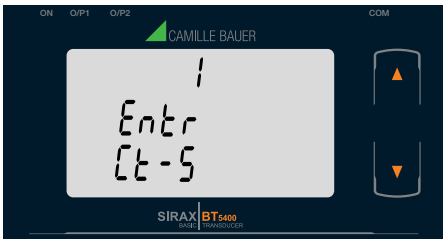

Pressing the “**Down**” key will enter transducer into “CT Secondary value edit” mode.

Pressing the “**Up**” key will confirm the present value as CT Secondary and advance to the Communication parameter Setting (section 7.1.7).

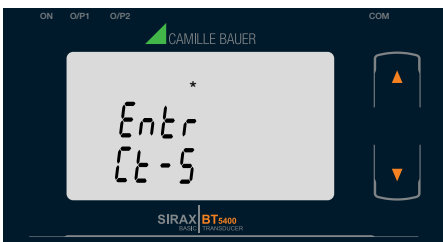

#### Editing Existing CT Secondary Value

(\*Denotes that digit will be flashing).

Pressing the “**Down**” key will scroll the value from 1 to 5 and value will roll back again to 1.

Pressing the “**Up**” key will advance the operation to the “ CT Secondary value confirmation”and set digit, in this case to “5”.



#### Confirmation of CT Secondary Value

Pressing the “**Down**” key will return to the “CT Secondary value edit” mode.

Pressing the “**Up**” key will confirm the CT Secondary and advance to the Communication parameter Selection (section 7.1.7).



## 7.1.7 Communication Parameter Setting

### 7.1.7.1 Address Setting

This screen applies to the RS 485 output only.

This screen allows the user to set RS485 parameter for instruments. The allowable range of address is 1 to 247.



Pressing “ Down” key will advance to the “address value edit” mode.

Pressing the “ Up” key will confirm the present value as address and advance to Baud Rate selection (section 7.1.7.2).



#### Editing Existing Address Value

(\*Denotes that digit will be flashing). First digit is always blank.

Pressing the “ Down” key will scroll the value of the second digit from 0 to 2 and the value will roll back again to 0. second digit set.

Pressing the “ Up” key will advance the operation to the next digit and set the third digit, in this case to “0”.



After, second digit gets entered, it will prompt for third digit.

(\*Denotes that digit will be flashing).

Pressing the “ Down” key will scroll the value of the third digit from 0 to 9 and the value will roll back again to 0 or it will get restricted depending on second digit set.

Pressing the “ Up” key will advance the operation to the next digit and set the third digit, in this case to “0”.



After third digit gets entered, it will prompt for fourth digit.

(\* denotes that digit will be flashing).

Pressing the “ Down” key will scroll the value of the fourth digit from 0 to 9 and the value will roll back again to 0 or it will get restricted depending on third digit set.

Pressing the “ Up” key will advance the operation to the “Address value confirmation” mode and set the fourth digit, in this case to “1”.

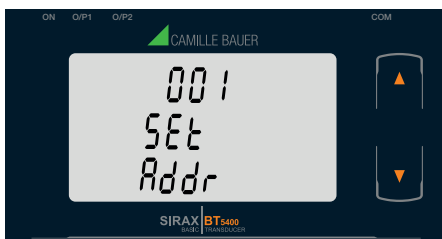

#### Confirmation of Address Value

Pressing the “ Down” key will re-enter to the “Address value edit” mode.

Pressing the “ Up” key will confirm Address value and advance to Baud Rate selection (section 7.1.7.2).

### 7.1.7.2 RS 485 Baud rate

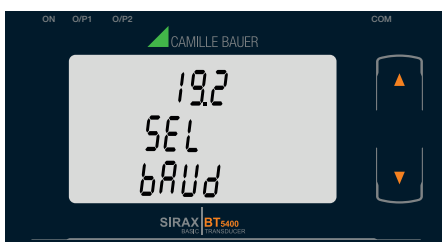

This screen allows the user to set Baud Rate of RS 485 port. The values displayed on screen are in kbaud.

Pressing the “ Down” key will enter into the “Baud Rate edit” mode and scroll the value between 2.4, 4.8, 9.6, 19.2 and value will roll back again to 2.4 (values are flashing).

Pressing “ Up” key will confirm the present value as Baud rate and advance to the RS485 Parity Selection (section 7.1.7.3).

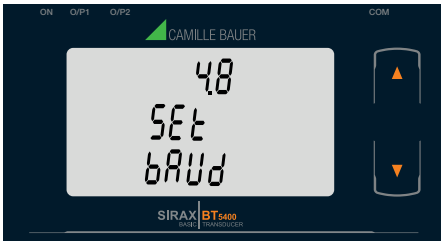

### Confirmation of RS 485 Baud Rate

Pressing “ Down” key will re-enter into the “Baud Rate edit” mode.

Pressing the “ Up” key will confirm the Baud rate value and advance to the Parity Selection (section 7.1.7.3).

### 7.1.7.3 RS 485 Parity Selection

This screen allows the user to set Parity & number of stop bits of RS 485 port.



Pressing the “ Down” key will enter into the “Parity & stop bit edit” mode and scroll the value between

- odd:** parity with one stop bit
- no. 1S:** no parity with one stop bit
- no. 2S:** no parity with two stop bit
- EVEn:** even parity with one stop bit

Pressing “ Up” key accepts the present value and Input Characteristics selection (section 7.1.8).



### Confirmation of RS 485 Parity

Pressing “ Down” key will re-enter into “Parity edit” mode.

Pressing the “ Up” key will set the value and advance to the Input Characteristics selection (section 7.1.8).

### 7.1.8 Input Characteristics Setting

#### 7.1.8.1 End value of Input

This screen allows the user to set the End value of Input with respect to system type & Transducer type. Allowable range of End value is 30% to 130% of Rated power. (Consider that we have Selected the Input as Apparent Power.)

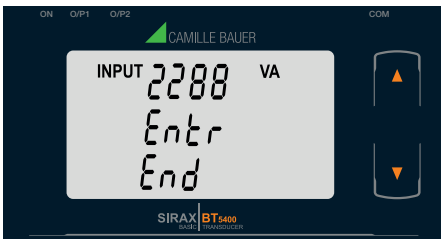

Pressing the “ Down” key will enter into “Input End value edit” mode.

Pressing “ Up” key will confirm the present value as Input End value and advance to the Start value of Input (section 7.1.8.2).

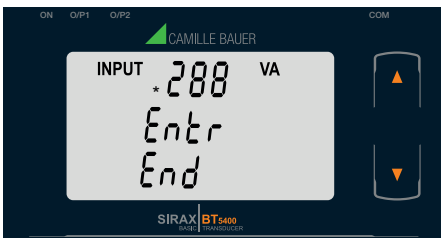

### Editing Existing Input End value

(\*Denotes that digit will be flashing).

\* Pressing the “ Down” key will scroll the value of the first digit from 0 to 5 and the value will roll back again to 0.

Pressing the “ Up” key will advance the operation to the next digit and set the first digit, in this case to “5”.

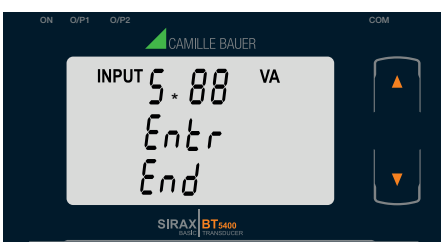

After first digit gets entered, it will prompt for second digit. (\*Denotes that digit will be flashing).

Pressing the “ Down” key will scroll the value of the second digit from 0 to 9, and the value will roll back again to 0 or get restricted depending on the value of first digit.

Pressing the “ Up” key will advance the operation to the next digit and set the second digit, in this case to “0”.

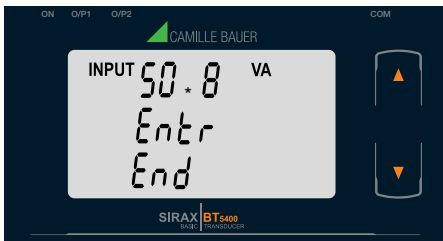

After second digit gets entered, it will prompt for third digit.  
(\*Denotes that digit will be flashing).

Pressing the “**Down**” key will scroll the value of the third digit from 0 to 9 and the value will roll back again to 0 or value will get restricted depending on the value of second digit.

Pressing the “**Up**” key will advance the operation to the next digit and set the third digit, in this case to “6”.

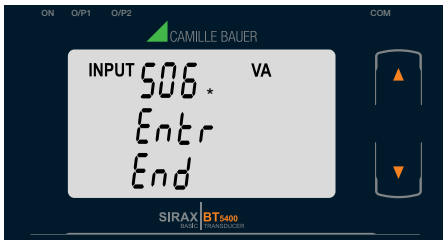

After third digit gets entered, it will prompt for fourth digit.  
(\*Denotes that digit will be flashing).

Pressing the “**Down**” key will scroll the value of the fourth digit from 0 to 9 and the value will roll back again to 0 or value will get restricted depending on the value of third digit.

Pressing the “**Up**” key will advance the operation to the next digit and set the fourth digit, in this case to “6”.

### Confirmation of End value

Pressing the “**Down**” key will re-enter to the “Input End value edit” mode.

Pressing the “**Up**” key will confirm end value of Input and advance to the Start value of Input selection (section 7.1.8.2).

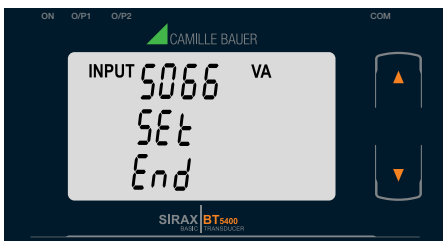

## 7.1.8.2 Start Value of Input

This screen allows the user to set the Start value of Input.

The band of the start value that can be set depends upon system type & Transducer type selected.

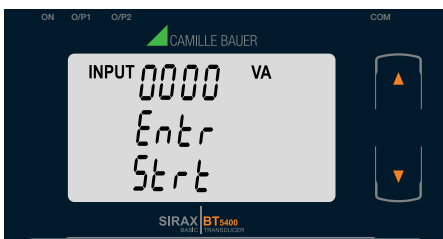

Start value can be set as follows:

1. 0 to 80% of end value for Apparent Power Transducer
2. -100% to 80% of end value for Active/Reactive Power Transducer
3. 0 to -175° for Phase angle Transducer. (Minimum span between End value and start value is 20°)
4. -0.996 to 0.984 for Power factor Transducer.

Pressing the “**Down**” key will enter into the Start value edit” mode Pressing “**Up**” key will confirm the present value and then advance to the Elbow function selection (section 7.1.8.3).

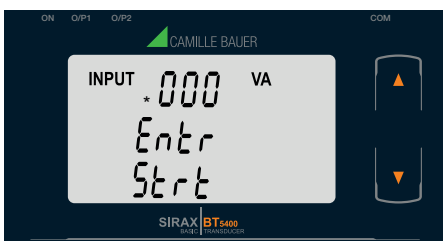

### Editing Existing Start Value

(\*Denotes that digit will be flashing).

Pressing the “**Down**” key will scroll the value of the first digit from 0 to 4 and value will roll back again to 0 or it will get restricted by set End value of Input.

Pressing the “**Up**” key will advance the operation to the next digit and set the first digit, in this case to “0”.

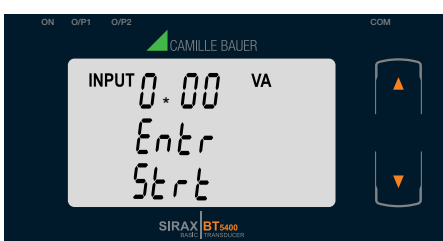

After first digit gets entered, it will prompt for second digit.  
(\*Denotes that digit will be flashing).

Pressing the “**Down**” key will scroll the value of the second digit from 0 to 9, and value will roll back again to 0 or it will get restricted depending on first digit set. Pressing the “**Up**” key will advance the operation to the next digit and set the second digit, in this case to “0”.

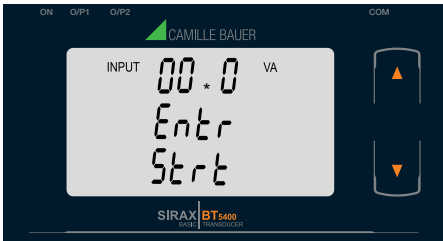

After second digit gets entered, it will prompt for third digit. (\* denotes that digit will be flashing).

Pressing the “**Down**” key will scroll from 0 to 9, and value will roll back again to 0 or it will get restricted depending on second digit set.

Pressing the “**Up**” key will advance the operation to Next digit and set the third digit, in this case to “5”.

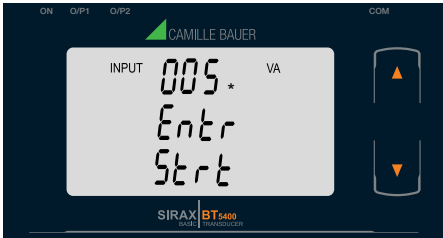

After third digit gets entered, it will prompt for fourth digit. (\* denotes that digit will be flashing).

Pressing the “**Down**” key will scroll from 0 to 9, and value will roll back again to zero or it will get restricted depending on third digit set.

Pressing the “**Up**” key will advance the operation to the “Input Start value confirmation” mode and set the fourth digit, in this case to “8”.

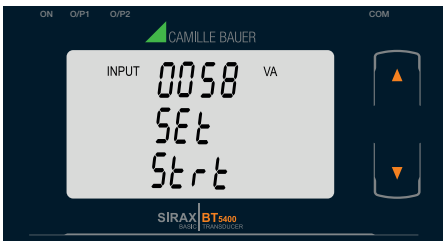

### Confirmation of Start value

Pressing the “**Down**” key will re-enter to the “Start value edit” mode.

Pressing the “**Up**” key will confirm Start value and advance to the Elbow function selection (section 7.1.8.3).

### 7.1.8.3 Elbow Function Selection

This screen allows the user to enable or disable Elbow function of input. This is applicable only for Active / Reactive / Apparent Transducer.

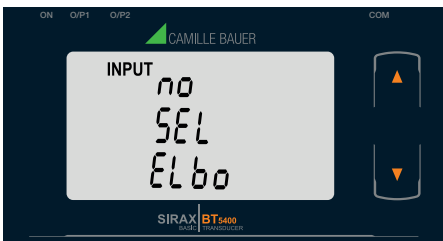

Pressing the “**Down**” key will enter the “Elbow enable or disable edit” mode and scroll the value between yes and no.

**YES:** Elbow function is enabled.

**no:** Elbow function is disabled.

Pressing “**Up**” key will accept the displayed condition. If Elbow function is enabled then transducer will advance to the Elbow value setting (section 7.1.8.4) otherwise advance to the output Characteristics selection (section 7.1.9).

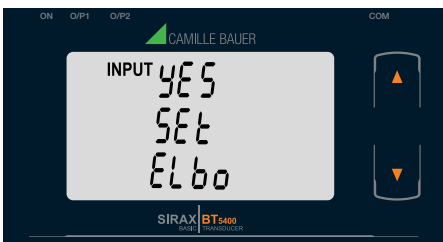

### Elbow enable/disable confirmation

Pressing “**Down**” key will re-enter into Elbow enable / disable Edit mode.

Pressing “**Up**” key will confirm the displayed condition and if enabled then will advance to the Elbow value of setting (section 7.1.8.4) otherwise Output Characteristics selection (section 7.1.9).

### 7.1.8.4 Elbow value of Input

This screen appears only when Elbow is enabled. This screen allows user to set Elbow value in-between (start value set+(0.015\*En value set)) and 98.5 % of the end value set.

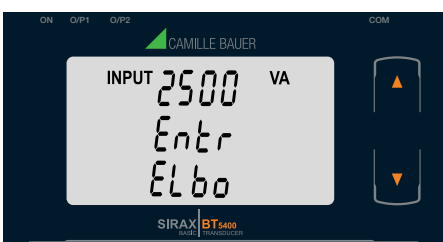

Pressing the “**Down**” key will enter into the “Input Elbow value edit” mode.

Pressing “**Up**” key will confirm the present value as Elbow value of the Input and advance to the Output characteristics selection (section 7.1.9).

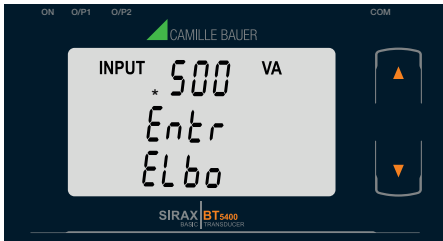

### Editing Existing Elbow value

(\*Denotes that digit will be flashing).

Pressing the “**Down**” key will scroll the value of the first digit from 0 to 5 and value will roll back again to 0 or it will get restricted depending upon start & end values set.

Pressing the “**Up**” key will advance the operation to the next digit and set the first digit, in this case to “3”.



After first digit gets entered, it will prompt for second digit.

(\*Denotes that digit will be flashing).

Pressing the “**Down**” key will scroll the value of the second digit from 0 to 9 and value will roll back again to 0 or it will get restricted depending on first digit set.

Pressing the “**Up**” key will advance the operation to the next digit and set the second digit, in this case to “0”.

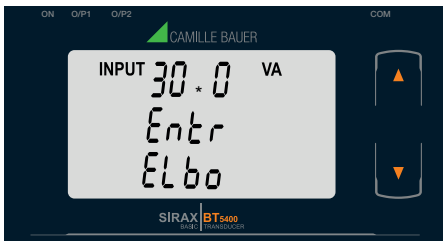

After second digit gets entered, it will prompt for third digit.

(\*Denotes that digit will be flashing).

Pressing the “**Down**” key will scroll the value of the third digit from 0 to 9 and value will roll back again to 0 or it will get restricted depending on second digit set.

Pressing the “**Up**” key will advance the operation to the next digit and set the third digit, in this case to “6”.

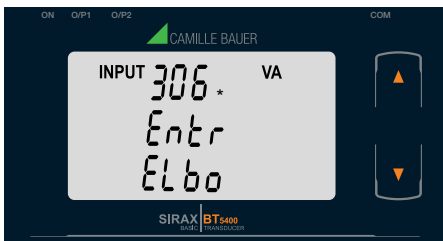

After third digit gets entered, it will prompt for fourth digit.

(\*Denotes that digit will be flashing).

Pressing the “**Down**” key will scroll the value of the fourth digit from 0 to 9 and value will roll back again to 0 or it will get restricted depending on third digit set.

Pressing the “**Up**” key will advance the operation to the “elbow value Confirmation” mode and set the fourth digit, in this case to “6”.

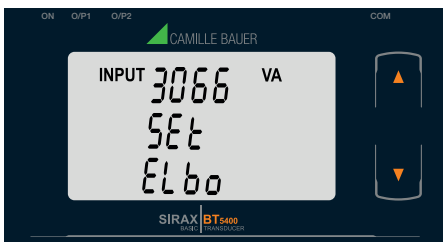

### Confirmation of Elbow value

Pressing the “**Down**” key will re-enter to the “Elbow value edit mode”.

Pressing the “**Up**” key will confirm Elbow value and advance to the output characteristics Selection (section 7.1.9).

## 7.1.9 Output Characteristics Setting

### 7.1.9.1 Output 1 Characteristics Setting

#### 7.1.9.1.1 End value of output 1

This screen will only appear to show output1 End value .It's not editable. The End value of Current Output should be 20mA & Voltage output should be 10V or depends upon user specified factory setting.

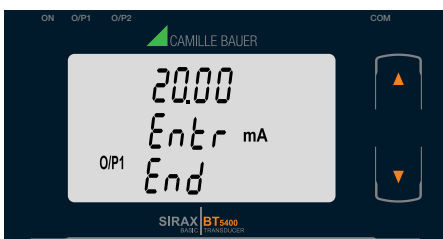

Pressing “**Down**” key value remains constant because End value is fixed.

Pressing “**Up**” key will confirm the present value as End value of the Output 1 and advance to the Start value of Output 1 (section 7.1.9.1.2).

### 7.1.9.1.2 Start value of output 1

This screen allows the user to set the Start value of Output 1, (considered as DC Current). Start value of output 1 can be set upto 20 % of set end value of output & minimum Start value setting depends upon transducer type. For Apparent transducer range of Start value setting can be done is 0 to 20% of End value.

For active/reactive/power factor/phase angle transducer range of Start value setting can be done is -100% to 20% of End value.

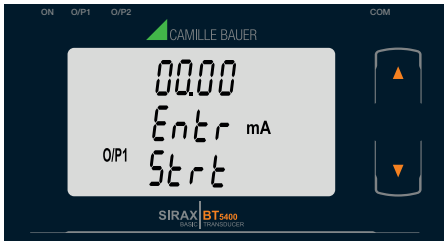

Pressing the “**Down**” key will enter the “output 1 Start value edit” mode.

Pressing “**Up**” key will confirm the present value as Start value and advance to the selection of Elbow value of output 1 if elbow function of input is enabled (section 7.1.9.1.3) Otherwise goes to output 2 characteristics selection(section 7.1.9.2)

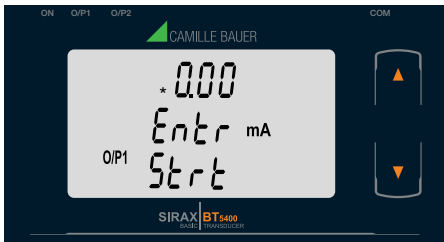

#### Editing Existing Start value

(\*Denotes that digit will be flashing).

Pressing the “**Down**” key will not affect the first digit It always remains 0.

Pressing the “**Up**” key will advance the operation to the next digit and set the first digit, in every case to “0”.

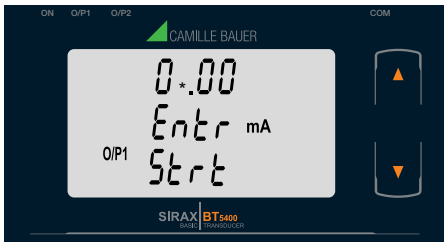

After first digit gets entered, it will Prompt for second digit.  
(\*Denotes that digit will be flashing).

Pressing the “**Down**” key will scroll the value of the second digit from 0 to 4 and value will roll back again to 0 or it will get restricted by output End value.

Pressing the “**Up**” key will advance the operation to the next digit and set the second digit, in this case to “4”.

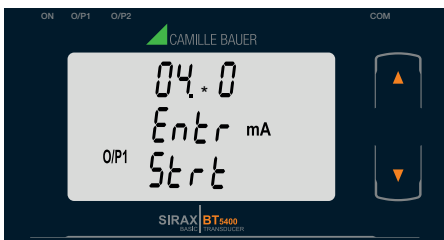

After second digit gets entered, it will prompt for third digit.

Pressing the “**Down**” key will scroll the value of the third digit from 0 to 9 and value will roll back again to 0 or it will get restricted depending on second digit set.

Pressing the “**Up**” key will advance the operation to the next digit and set the third digit, in this case to “0”.

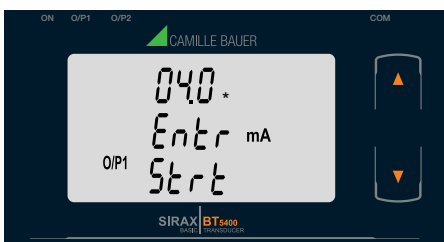

After third digit gets entered, it will Prompt for fourth digit

Pressing the “**Down**” key will scroll the value of the fourth digit from 0 to 9 and it will roll back again to 0 or it will get restricted depending on third digit set.

Pressing the “**Up**” key will advance the operation to the “confirmation of Output 1 start value” and set the fourth digit, in this case to “0”.

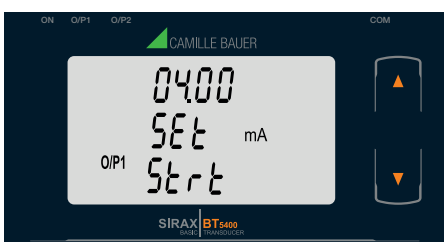

#### Confirmation of Start value

Pressing the “**Down**” key will re-enter to the “Output 1 Start value edit” mode.

Pressing the “**Up**” key will confirm Start value and advance to the selection of Elbow value of Output (section 7.1.9.1.3) if input elbow is enabled or output 2 characteristics setting (section 7.1.9.3)

### 7.1.9.1.3 Elbow value of output 1

This screen appears only when Elbow is enabled. This screen allows user to set Elbow value in-between start value and end value set.



Pressing the “ Down” key will enter the “ output 1 Start value edit” mode.

Pressing “ Up” key will confirm the present value as Start value and advance to the selection of Elbow value of output 1 if elbow function of input is enabled (section 7.1.9.1.3) Otherwise goes to output 2 characteristics selection (section 7.1.9.2).



Pressing the “ Down” key will enter the “ Output 1 Elbow value edit” Mode.

Pressing “ Up” key will set the present value as Elbow value of the Output 1 and advance to the Output 2 Characteristics selection (section 7.1.9.3).

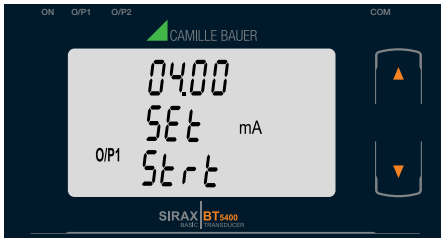

#### Editing Existing Elbow value

(\*Denotes that digit will be flashing).

Pressing the “ Down” key will scroll the value of the first digit from 0 to 2 and it will roll back again to 0 or it will get restricted by start value and End value set.

Pressing the “ Up” key will advance the operation to the next digit and set the first digit, in this case to “1”.

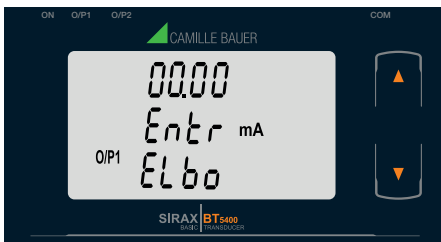

After first digit gets entered, it will prompt for second digit.

(\*Denotes that digit will be flashing).

Pressing the “ Down” key will scroll the value of the second digit from 0 to 9 and it will roll back again to 0 or it will get restricted depending on first digit set.

Pressing the “ Up” key will advance the operation to the next digit and set the second digit, in this case to “6”.



After second digit gets entered, it will prompt for third digit.

Pressing the “ Down” key will scroll the value of the third digit from 0 to 9 and it will roll back again to 0 or it will get restricted depending on second digit set.

Pressing the “ Up” key will advance the operation to the next digit and set the third digit, in this case to “0”.



After third digit gets entered, it will prompt for fourth digit.

Pressing the “ Down” key will scroll the value of the fourth digit from 0 to 9 and it will roll back again to 0 or it will get restricted depending on third digit set.

Pressing the “ Up” key will advance the operation to the “ Output 1 Elbow value confirmation ”mode and set the fourth digit, in this case to “0”.



Confirmation of Elbow value Pressing the “**Down**” key will re-enter into the “ Elbow value edit” mode.

Pressing the “**Up**” key will confirm Elbow value and advance to the Output 2 characteristics selection (section 7.1.9.2).

## 7.1.9.2 Output 2 Characteristics Setting

### 7.1.9.2.1 End value of output 2

This screen will only appear to show output End value of Output 2. It's not editable. The End value of Current Output should be 20mA & Voltage output should be 10 V or depends upon user specified factory setting.

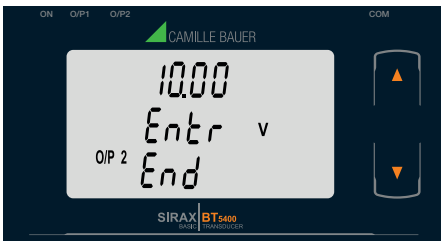

Pressing “**Down**” key value remains constant because output 2 End value is fixed.

Pressing “**Up**” key will confirm the present value as End value and advance to the Start value of Output 2 (section 7.1.9.2.2).

### 7.1.9.2.2 Start value of output 2

This screen allows the user to set the Start value of Output. For Apparent transducer range of Start value setting can be done is 0 to 20% of End value. For active/reactive/power factor/phase angle transducer range of Start value setting can be done is -100% to 20% of End value.



Pressing the “**Down**” key will enter the “Output 2 Start value edit” mode.

Pressing “**Up**” key will confirm the present value as Start value of the Output 2 and advance to the Elbow value of Output 2 selection (section 7.1.9.2.3) if elbow function of input is enabled otherwise advance to the Mode selection (section 7.1.9).

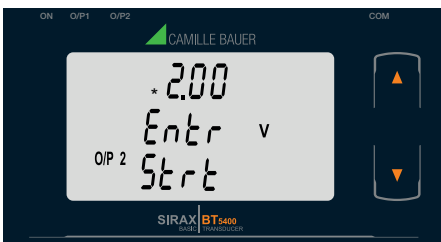

### Editing Existing Start value

(\*Denotes that digit will be flashing).

Pressing the “**Down**” key will not affect the value of first digit, it is always 0.

Pressing the “**Up**” key will advance the operation to the next digit and set the first digit, in every case to “0”.



After, first digit gets entered, it will prompt for second digit.

(\*Denotes that digit will be flashing).

Pressing the “**Down**” key will scroll the value of the second digit from 0 to 9 and it will roll back again to 0 or it will get restricted by end value set.

Pressing the “**Up**” key will advance the operation to the next digit and set the second digit, in this case to “0”.

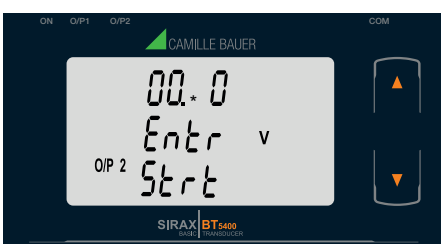

After, second digit gets entered, it will prompt for third digit.

(\*Denotes that digit will be flashing).

Pressing the “**Down**” key will scroll the value of the third digit from 0 to 9 and it will roll back again to 0 or it will get restricted depending on second digit set.

Pressing the “**Up**” key will advance the operation to the next digit and set the third digit, in this case to “0”.



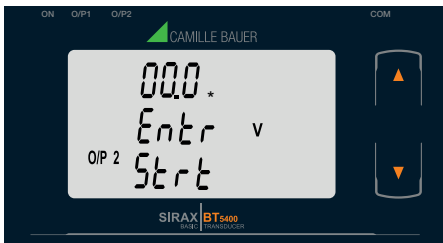

After, third digit gets entered, it will prompt for fourth digit.  
 (\*Denotes that digit will be flashing).

Pressing the “**⬇** Down” key will scroll the value of the fourth digit from 0 to 1 and it will roll back again to 0 or it will get restricted depending on third digit set.

Pressing the “**⬆** Up” key will advance the operation to the “ Output 2 Elbow value confirmation ” mode and set the fourth digit, in this case to “0”.

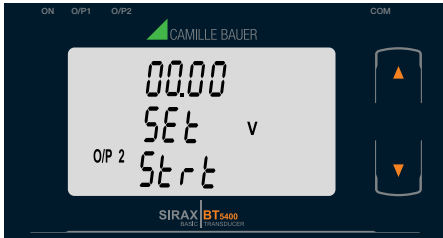

Confirmation of Start value Pressing the “**⬇** Down” key will re-enter to the “Output 2 Start value edit ” mode.

Pressing the “**⬆** Up” key will confirm Output 2 Start value and advance to the Elbow value of Output 2 selection (section 7.1.9.2.3) if input elbow is enable or Mode Selection (section 7.1.10).

### 7.1.9.2.3 Elbow value of output 2

This screen appears only when Output 2 Elbow is enabled. This screen allows user to set Elbow value in-between start value and end value set.



Pressing the “**⬇** Down” key will enter the “ Output 2 Elbow value edit ” mode.

Pressing “**⬆** Up” key will confirm the present value as Elbow value and advance to the Mode Selection (section 7.1.10).

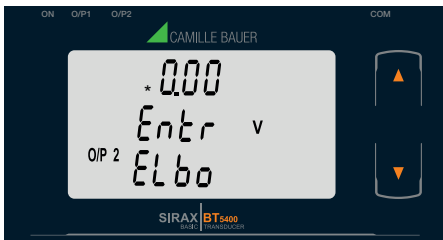

#### Editing Existing Elbow value

(\*Denotes that digit will be flashing).

Pressing the “**⬇** Down” key will scroll the value of the first digit from 0 to 1 and it will roll back again to 0 or it will get restricted by End value and start value set.

Pressing the “**⬆** Up” key will advance the operation to the next digit and set the first digit, in this case to “0”.



After, first digit gets entered, it will prompt for second digit.  
 (\*Denotes that digit will be flashing).

Pressing the “**⬇** Down” key will scroll the value of the second digit from 0 to 9 and it will roll back again to 0 or it will get restricted depending on first digit set.

Pressing the “**⬆** Up” key will advance the operation to the next digit and set the second digit, in this case to “6”.



After, second digit gets entered, it will prompt for third digit.  
 (\*Denotes that digit will be flashing).

Pressing the “**⬇** Down” key will scroll the value of the third digit from 0 to 9 and it will roll back again to 0 or it will get restricted depending on second digit set.

Pressing the “**⬆** Up” key will advance the operation to the next digit and set the third digit, in this case to “5”.



After, third digit gets entered, it will prompt for fourth digit.  
 (\*Denotes that digit will be flashing).

Pressing the “ Down” key will scroll the value of the fourth digit from 0 to 9 and it will roll back again to 0 or it will get restricted depending on third digit set.

Pressing the “ Up” key will advance the operation to the “Elbow value Confirmation” mode and set the fourth digit, in this case to “0”.



### Confirmation of Elbow value

Pressing the “ Down” key will re-enter to the “Output 2 Elbow value edit ” mode.

Pressing the “ Up” key will confirm Elbow value and advance to Mode Selection (Section 7.1.10).



## 7.1.10 Mode Selection



This screen allows the user to set Mode Selection.

Normal mode: Only Input & Output parameters are displayed.

Diagnosis mode: All 3X measured parameters are displayed.

Pressing the “ Down” key will enter into the “Mode Selection edit” mode and scroll between **nor**: Normal Mode and DIA: Diagnosis Mode and will roll back again to Normal mode. Pressing “ Up” key will confirm the present mode as operating mode and exit the setup menu.

**Note:** After power ON / OFF Transducer goes by default to normal mode.



### Mode confirmation

Pressing “ Down” key will be re-enter into the. “Mode selection edit” mode.

Pressing the “ Up” key will confirm the operating mode and exit the setup menu.

# 8. Phasor Diagram

- Quadrant 1:** 0° to 90°
- Quadrant 2:** 90° to 180°
- Quadrant 3:** 180° to 270°
- Quadrant 4:** 270° to 360°

In this diagram a technical visualization of the current and voltage phasors is shown, using a clockwise rotation.

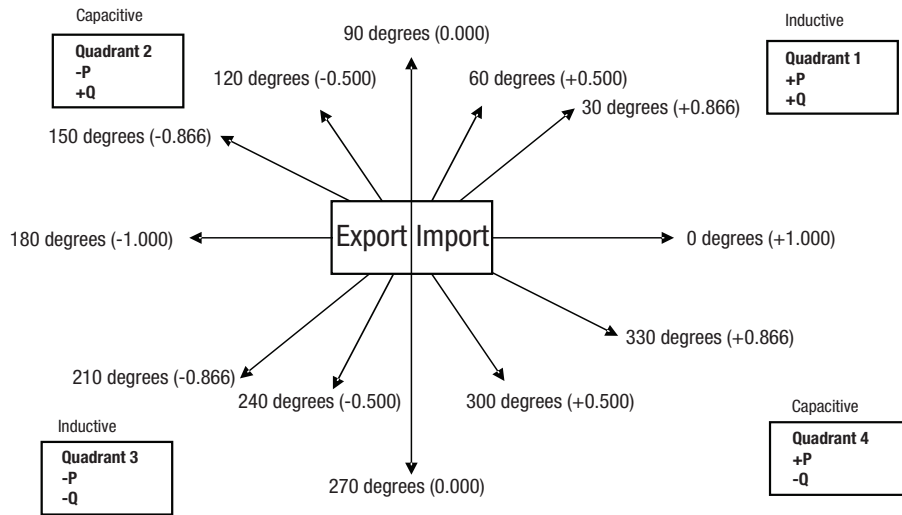

Connections	Quadrant	Sign of Active Power (P)	Sign of Reactive Power (Q)	Sign of Power Factor (PF)	Inductive/ Capacitive
Import	1	+ P	+ Q	+	L
Import	4	+ P	- Q	+	C
Export	2	- P	+ Q	-	C
Export	3	- P	- Q	-	L

**Inductive means Current lags Voltage**  
**Capacitive means Current leads Voltage**

When the instrument displays Active power (P) with “+” (positive sign), the connection is “**Import**” .  
 When the instrument displays Active power (P) with “-” (negative sign), the connection is “**Export**” .

## Examples of measuring ranges with Phase angle

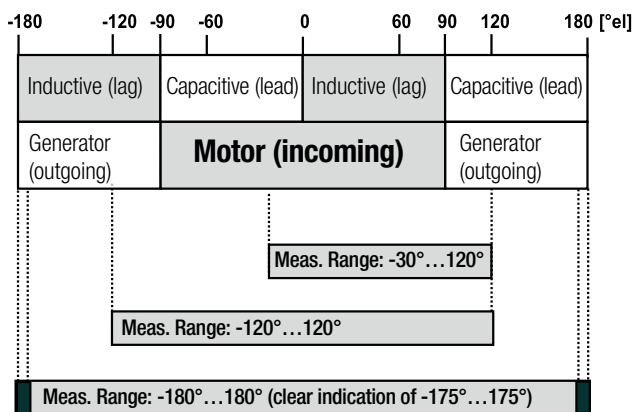

## Examples of measuring ranges with Phase cos

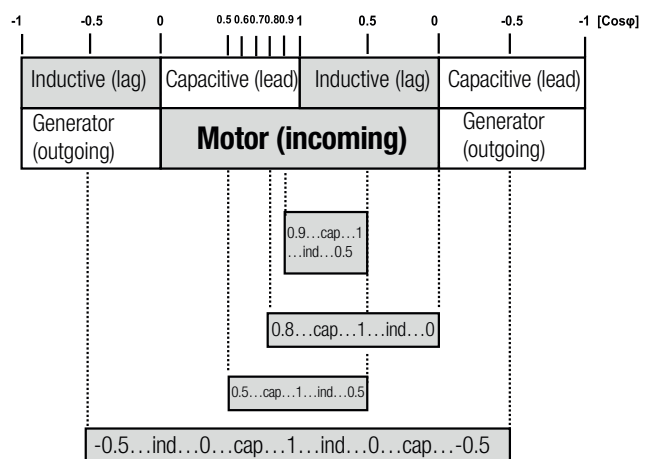

## 9. Programming via the programming connection and the PRKAB5000 programming cable

Follow the subsequent steps to program the SIRAX BT5400 transducer via the programming connection and the PRKAB5000 programming cable:

### Step 1: DIP switch setting

The DIP switches should be configured for the desired measurement output as described in Chapter 7.4.

### Step 2: Connection

Connect PC PRKAB5000 transducer according to diagram. Please observe that the power supply for the transducer must be connected prior to programming. The installation position is irrelevant.

### Step 3: Programming

Program is effected via a PC, the CB-Configurator software and the PRKAB5000 programming cable.

The CB-Configurator software may be downloaded via our homepage [www.camillebauer.com](http://www.camillebauer.com).

The PRKAB5000 programming cable assumes the signal level and also provides the galvanic isolation between the PC connection and the programming connection at the transducer.

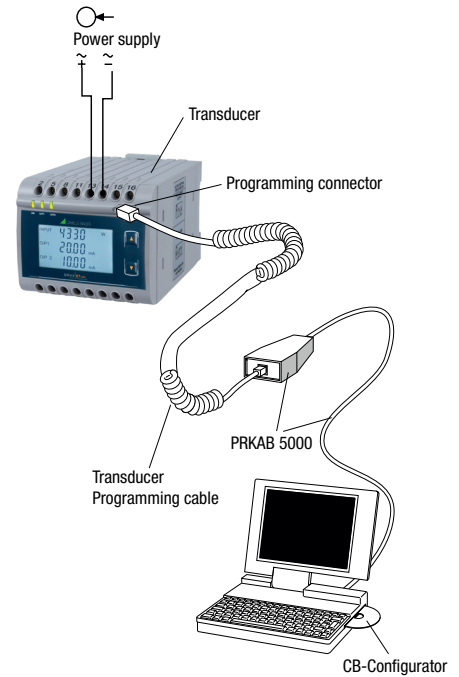

## 9.1 Programming via the RS485 (Modbus) interface

Follow the subsequent steps to program the transducer via the RS485 interface and Modbus:

### Schritt 1: DIP switch setting

The DIP switches must be configured for the desired output type as described in Section 7.4.

### Schritt 2: Connection

Connect the Modbus cable according to the connection diagram in Chapter 13.3. Please observe also the information in the Modbus (RS485) interface definition in Chapter 13.

### Schritt 2: Programming

Program SIRAX BT5400 via the Modbus RTU interface and the CB-Configurator software. Please observe the detailed Modbus description in Chapter 13.

To change the output from current to voltage, enter the value "1".

To change the output from voltage to current, enter the value "2".

(See Section 13.2 and Table 2 Parameter No. 16 & 18 for the details).

Connect the power supply to SIRAX BT5400 before programming.

## 9.2 DIP Switch Setting for Output

To configure SIRAX BT5400 Output, programming method to be adapted along with mechanical switch setting (DIP switch setting on PCB).

Type of output (current or voltage signal) has to be set by DIP switch.

Remove Sticker for o/p Selection

DIP Switch setting	Type of output signal
	load-independent current
	load-independent voltage

NOTE: Black portion in above diagram indicate switch position.

## 10. Service, maintenance and disposal



For devices that have not been opened in the factory, no warranty or guarantee can be assumed.

### 10.1 Repair work and modifications

Repair work and modifications shall exclusively be carried out by the manufacturer. Do not open the housing of the device. In case of any tampering with the device, the warranty claim shall lapse. We reserve the right of changing the product to improve it.

### 10.2 Calibration and new adjustment

Each device is adjusted and checked before delivery. The condition as supplied to the customer is measured and stored in electronic form.

The uncertainty of measurement devices may be altered during normal operation if, for example, the specified ambient conditions are not met.

### 10.3 Cleaning

The display and the operating keys should be cleaned in regular intervals. Use a dry or slightly moist cloth for this.



#### Damage due to detergents

Detergents may not only affect the clearness of the display but also can damage the device. Therefore, do not use detergents.

### 10.4 Disposal



The disposal of devices and components may only be realised in accordance with good professional practice observing the country-specific regulations. Incorrect disposal can cause environmental risks.

### 10.5 Return

All devices delivered to Camille Bauer Metrawatt AG shall be free of any hazardous contaminants (acids, lyes, solutions, etc.). Use original packaging or suitable transport packaging to return the device.



#### Damage by returning

Damages caused by improper returning, no warranties or guarantees can be given.

## 11. Technical data

### Inputs

Nominal voltage (U <sub>n</sub> ):	100 ... 500 V <sub>L-L</sub>
Potential transformer primary value:	100 ... 692,8 kV <sub>L-L</sub>
Nominal frequency (f <sub>n</sub> ):	25 ... 60Hz
Rated load input voltage:	< 0.6 VA per phase at U <sub>n</sub>
Overload capacity:	1.2 * U <sub>n</sub> permanently, 2 * U <sub>n</sub> for 1 sec., 10 repetitions in 10 minute intervals.
Rated current (I <sub>n</sub> ):	1 ... 5A
Current transformer primary value:	1 ... 9999A
Nominal frequency (f <sub>n</sub> ):	25 ... 60Hz
Rated load input voltage:	< 0.2 VA per phase at U <sub>n</sub>
Overload capacity:	1.2 * I <sub>n</sub> permanently, 10 * I <sub>n</sub> for 3 sec., 5 repetitions in 5 minute intervals. 50 * I <sub>n</sub> for 1 sec., 1 repetition in 60 minute intervals.

### Power supply

Nominal voltage:	60 ... 300V AC/DC ±5%
Frequency range:	45 ... 65 Hz
Consumption:	≤ 8 VA for 1 output ≤ 10 VA for 2 outputs

### Measuring Output Y (Single or Optional Dual)

Output type Y2:	Load independent DC Voltage or DC Current (Onsite selectable through DIP switches & Programming.)
Load independent DC output:	Unipolar: 0 ... 20mA / 4 ... 20mA or 0 ... 10V Bipolar: -20mA ... 0 ... +20mA or -10V ... 0 ... +10V
Output burden with DC current output Signal:	0 ≤ R ≤ 15V/Y2
Output burden with DC voltage output Signal:	Y2/(2 mA) ≤ R ≤ ∞
Current limit under overload R=0:	≤ 1.25 * Y2 with current output ≤ 60 mA with Voltage output
Voltage limit under R=∞:	< 1.25 * Y2 with voltage output ≤ 30 V with current output
Residual Ripple in Output signal:	≤ 1% pk-pk
Response Time:	≤ 750 ms.

### Accuracy (Acc. to EN 60688)

Reference Value:	Output end Value Y2 (Voltage or Current)
Basic Accuracy for power transducer:	0.2°C
Basic Accuracy for for Phase Angle & power factor transducer	
Factor C (The Highest value applies):	0.5°C

Linear characteristics:

$$C = \frac{1 - \frac{Y_0}{Y_2}}{1 - \frac{X_0}{X_2}} \text{ or } C=1$$

Bent characteristics:

$$C = \frac{Y_1 - Y_0}{X_1 - X_0} \cdot \frac{X_2}{Y_2} \text{ or } C=1$$

$$C = \frac{1 - \frac{Y_1}{Y_2}}{1 - \frac{X_1}{X_2}} \text{ or } C=1$$

## Output characteristics:

1) Example of setting with Linear characteristics:

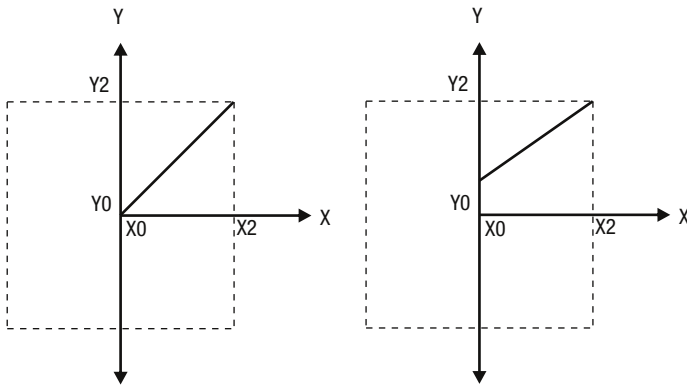

2) Example of setting with Bent characteristics:

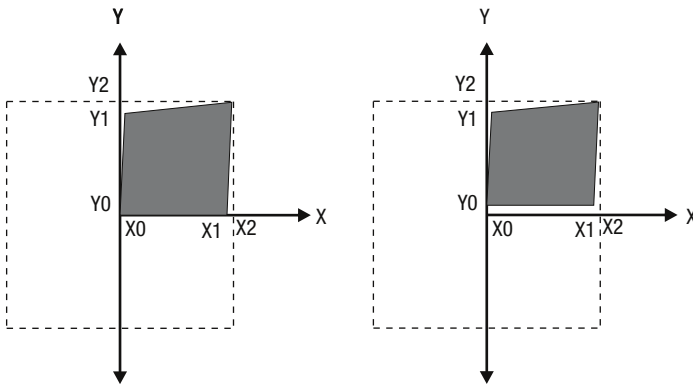

X0 = Start value of input  
 X1 = Elbow value of input  
 X2 = End value of input  
 RN = Rated value of output burden

Y0 = Start value of output  
 Y1 = Elbow value of output  
 Y2 = End value of output  
 UN/IN = Nominal input voltage/current

## Reference conditions for Accuracy

Ambient temperature:	23°C +/- 1°C
Pre-conditioning:	30 min acc. to EN 60688
Input Variable:	Rated Voltage / Rated Current
Input waveform:	Sinusoidal
Input signal frequency:	50 ... 60Hz
Active / Reactive / PF:	Cos Φ=1 resp. Sin Φ = 1
For Phase Angle & Power Factor Transducer	
Reference Value:	For Phase angle = 90° resp. For power factor = 0.5
Auxiliary supply voltage:	Rated Value ±1%
Auxiliary supply frequency:	Rated Value ±1%
Output Load:	Rn = 7.5 V / Y2 ± 1% With DC current output signal. Rn = Y2 / 1 mA ± 1% With DC Voltage output signal.

## Additional Error:

Temperature influence: ± 0.2% /10 K

## Safety

Protection Class:	II (Protection Isolated acc. to EN 61010-1, EN 61010-2-030)
Protection:	IP 40, housing according to EN 60529 IP 20, terminal according to EN 60529
Pollution degree:	2

Installation Category: III, 300V  
 Insulation Voltage: 50Hz, 1min. (EN 61010-1)  
 3700V, Input versus all other circuits  
 3700V, Auxiliary supply versus outer surface and output  
 490V, Output versus output versus each other versus outer surface.

### Installation Data:

Material: Lexan 940 (polycarbonate),  
 V-0 acc. to UL94, self-extinguishing,  
 non-dripping, free of halogen  
 Mounting position: Rail mounting / wall mounting  
 Weight: Approx. 0.4kg

### Connection Terminal

Connection Element: Conventional Screw type terminal with indirect wire pressure  
 Permissible cross section of the connection lead:  $\leq 4.0$  mm single wire or 2 x 2.5 mm Fine wire

### Environmental

Nominal range of use: 0 °C ... 23 °C ... 45 °C (usage Group II)  
 Storage temperature: -40 °C to 70 °C  
 Relative humidity of annual mean:  $\leq 75\%$   
 Altitude: 2000m max

### Ambient tests:

EN 60068-2-6: Vibration  
 Acceleration:  $\pm 2$  g  
 Frequency range: 10 ... 150 ... 10Hz,  
 Rate of frequency sweep: 1 octave/minute  
 Number of cycles: 10, in each of the three axes  
 EN 60068-2-7: Shock  
 Acceleration: 3 x 50g  
 3 shocks in each direction  
 EN 60068-2-1/-2/-3 Cold, Dry, Damp heat  
 EN 61000-4-2/-3/-4/-5/-6 EN 55011 Electromagnetic compatibility

## 12. Dimensional drawings

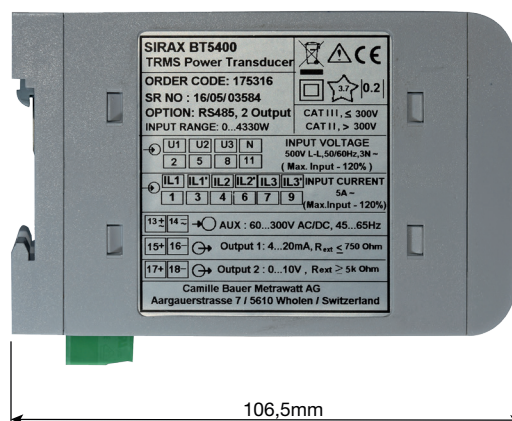



## 13. Interface Definition Modbus RTU

SIRAX BT5400 supports Modbus RTU protocol (RS485).

The permissible address range for the BT5400 is between 1 and 247. Broadcast Mode (address 0) is not allowed.

The maximum latency time of an BT5400 is 200ms i.e. this is the amount of time that can pass before the first response character is output.

After sending any query through software (of the Master), it must allow 200ms of time to elapse before assuming that the BT5400 is not going to respond. If slave does not respond within 200 ms, Master can ignore the previous query and can issue fresh query to the slave.

### 13.1 Modbus functions

Following code functions are provide:

Function code	Function	Address
03	Read holding registers	40001 to 40042
04	Read input registers	30001 to 30078
16	Presets multiple registers	40001 to 40042

#### Example of read out measurement

Query:

Device address	Function code	Start address	Nr. of register	CRC
0x05	0x04	0x0000	0x0002	0x3181

Response:

Device address	Function code	Nr. of databytes	Databytes 0 ... 3	CRC
0x05	0x04	0x04	0x40174C05	0xEF43

#### Example of set slave address to 2

Query:

Device address	Function code	Start address	Nr. of register	Nr. of bytes	Databytes 0...3	CRC
0x01	0x10	0x000E	0x0002	0x04	0x40000000	0x67E3

Response:

Device address	Function code	Start address	Nr. of register	CRC
0x01	0x10	0x000E	0x0002	0x200B

Exception Cases: An exception code will be generated when BT5400 receives ModBus query with valid parity and error check but which contains some other error (e.g. Attempt to set floating point variable to an invalid value). The response generated will be "Function code" + 0x80.

01	Illegal function	The function code is not supported.
02	Illegal data address	Attempt to access an invalid address or an attempt to read or write part of a floating point value.
03	Illegal data value	Attempt to set a floating point variable to an invalid value.

### 13.2 Data types

All information are displayed as 32-bit float. There is no representation for floating point numbers in the Modbus specification.

The IEEE 754 standard as the most often used standard for the representation of floating numbers is applied.

- The first register contains the bits 16 – 31
- The second register contains the bits 0 – 15

32-Bit Float (Real32)

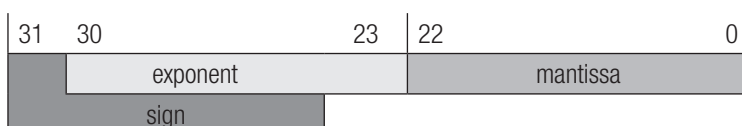

0x4017																0x4C05																						
0	1	0	0	0	0	0	0	0	0	0	0	0	0	0	0	0	0	1	0	1	1	1	0	1	0	0	1	1	0	0	0	0	0	0	0	1	0	1
+		Exponent: 128-127=1										Mantisse=1.0100000000101110100110000000101=1.18200743198394781526789																										

Measuring value P = 1.18200743198394781526789 \* 2<sup>1</sup> = 2.3640149 W

### 13.3 Modbus Register

Address (Register)	Name	Read/Write	Description																																				
30001	Voltage UL1N	R	Voltage between phase L1 and neutral																																				
30003	Voltage UL2N	R	Voltage between phase L2 and neutral																																				
30005	Voltage UL3N	R	Voltage between phase L3 and neutral																																				
30007	Current IL1	R	Current phase L1																																				
30009	Current IL2	R	Current phase L2																																				
30011	Current IL3	R	Current phase L3																																				
30043	Mean value of voltage	R	Mean value of phase voltage $U_m = 1/3 (UL1N + UL2N + UL3N)$																																				
30047	Mean value of current	R	Mean value of phase current $I_m = 1/3 (IL1 + IL2 + IL3)$																																				
30053	Active Power	R	Active power system ( $P=P1+P2+P3$ )																																				
30057	Apparent power	R	Apparent power system																																				
30061	Reactive power	R	Reactive power system ( $Q = Q1 + Q2 + Q3$ )																																				
30063	Power factor	R	Active power factor $P / S$																																				
30067	Phase angle	R	Angle between P and S																																				
30071	Frequency	R	System frequency																																				
30073	UL12	R	Voltage between phase L1 and L2																																				
30075	UL23	R	Voltage between phase L2 and L3																																				
30077	UL31	R	Voltage between phase L3 and L1																																				
40001	–	–	–																																				
40003	Mode selection	R/W	This is used to select the Mode of operation. Normal mode = 1 Simulation mode = 2																																				
40005	System Type	R/W	This is used to select the system type. <table border="1" data-bbox="587 1093 1481 1619"> <thead> <tr> <th>Value</th> <th>Description</th> <th>Active/ Apparent/ Reactive power</th> <th>Power factor/ Phase angle</th> </tr> </thead> <tbody> <tr> <td>1</td> <td>Single phase system</td> <td>x</td> <td>x</td> </tr> <tr> <td>2</td> <td>3-wire, 3-phase system balanced load</td> <td>x</td> <td>x</td> </tr> <tr> <td>3</td> <td>3-wire, 3-phase system unbalanced load, Aron</td> <td>x</td> <td>–</td> </tr> <tr> <td>4</td> <td>4-wire, 3-phase system unbalanced load</td> <td>x</td> <td>–</td> </tr> <tr> <td>5</td> <td>3-wire, 3-phase system balanced load, phase shift UL12 - IL1</td> <td>–</td> <td>x</td> </tr> <tr> <td>6</td> <td>3-wire, 3-phase system balanced load, phase shift UL23 - IL1</td> <td>–</td> <td>x</td> </tr> <tr> <td>7</td> <td>3-wire, 3-phase system balanced load, phase shift UL31 - IL1</td> <td>–</td> <td>x</td> </tr> <tr> <td>8</td> <td>4-wire, 3-phase system balanced load</td> <td>x</td> <td>x</td> </tr> </tbody> </table>	Value	Description	Active/ Apparent/ Reactive power	Power factor/ Phase angle	1	Single phase system	x	x	2	3-wire, 3-phase system balanced load	x	x	3	3-wire, 3-phase system unbalanced load, Aron	x	–	4	4-wire, 3-phase system unbalanced load	x	–	5	3-wire, 3-phase system balanced load, phase shift UL12 - IL1	–	x	6	3-wire, 3-phase system balanced load, phase shift UL23 - IL1	–	x	7	3-wire, 3-phase system balanced load, phase shift UL31 - IL1	–	x	8	4-wire, 3-phase system balanced load	x	x
Value	Description	Active/ Apparent/ Reactive power	Power factor/ Phase angle																																				
1	Single phase system	x	x																																				
2	3-wire, 3-phase system balanced load	x	x																																				
3	3-wire, 3-phase system unbalanced load, Aron	x	–																																				
4	4-wire, 3-phase system unbalanced load	x	–																																				
5	3-wire, 3-phase system balanced load, phase shift UL12 - IL1	–	x																																				
6	3-wire, 3-phase system balanced load, phase shift UL23 - IL1	–	x																																				
7	3-wire, 3-phase system balanced load, phase shift UL31 - IL1	–	x																																				
8	4-wire, 3-phase system balanced load	x	x																																				
40007	Primary voltage	R/W	This address allows the user to read and write PT Primary value. The PT Primary value can be set between 100 to 692.8 KVLL and also depends upon the per phase 1000 MVA Restriction of power combined with CT Primary.																																				
40009	Secondary voltage	R/W	This address is used to read and write the PT secondary value in range between 100V to 500V L-L.																																				
40011	Primary current	R/W	This address allows the user to read and write CT Primary value. The maximum settable value is 9999 & also depends on the per phase 1000 MVA Restriction of power combined with PT primary.																																				
40013	Secondary current	R/W	This address is used to read and write the CT secondary value in range between 1A to 5A.																																				

Address (Register)	Name	Read/Write	Description																																																																								
40015	Device Adress	R/W	This address is used to set the Device Address between 1 to 247.																																																																								
40017	RS 485 Set up	R/W	<p>This address is used to set the Baud rate, Parity and number of stop bits.</p> <table border="1"> <thead> <tr> <th>Value</th> <th>Baud rate</th> <th>Parity</th> <th>Stop bit</th> <th>Value</th> <th>Baud rate</th> <th>Parity</th> <th>Stop bit</th> </tr> </thead> <tbody> <tr> <td>0</td> <td>2400</td> <td>NONE</td> <td>1</td> <td>8</td> <td>9600</td> <td>NONE</td> <td>1</td> </tr> <tr> <td>1</td> <td>2400</td> <td>NONE</td> <td>2</td> <td>9</td> <td>9600</td> <td>NONE</td> <td>2</td> </tr> <tr> <td>2</td> <td>2400</td> <td>EVEN</td> <td>1</td> <td>10</td> <td>9600</td> <td>EVEN</td> <td>1</td> </tr> <tr> <td>3</td> <td>2400</td> <td>ODD</td> <td>1</td> <td>11</td> <td>9600</td> <td>ODD</td> <td>1</td> </tr> <tr> <td>4</td> <td>4800</td> <td>NONE</td> <td>1</td> <td>12</td> <td>19200</td> <td>NONE</td> <td>1</td> </tr> <tr> <td>5</td> <td>4800</td> <td>NONE</td> <td>2</td> <td>13</td> <td>19200</td> <td>NONE</td> <td>2</td> </tr> <tr> <td>6</td> <td>4800</td> <td>EVEN</td> <td>1</td> <td>14</td> <td>19200</td> <td>EVEN</td> <td>1</td> </tr> <tr> <td>7</td> <td>4800</td> <td>ODD</td> <td>1</td> <td>15</td> <td>19200</td> <td>ODD</td> <td>1</td> </tr> </tbody> </table>	Value	Baud rate	Parity	Stop bit	Value	Baud rate	Parity	Stop bit	0	2400	NONE	1	8	9600	NONE	1	1	2400	NONE	2	9	9600	NONE	2	2	2400	EVEN	1	10	9600	EVEN	1	3	2400	ODD	1	11	9600	ODD	1	4	4800	NONE	1	12	19200	NONE	1	5	4800	NONE	2	13	19200	NONE	2	6	4800	EVEN	1	14	19200	EVEN	1	7	4800	ODD	1	15	19200	ODD	1
Value	Baud rate	Parity	Stop bit	Value	Baud rate	Parity	Stop bit																																																																				
0	2400	NONE	1	8	9600	NONE	1																																																																				
1	2400	NONE	2	9	9600	NONE	2																																																																				
2	2400	EVEN	1	10	9600	EVEN	1																																																																				
3	2400	ODD	1	11	9600	ODD	1																																																																				
4	4800	NONE	1	12	19200	NONE	1																																																																				
5	4800	NONE	2	13	19200	NONE	2																																																																				
6	4800	EVEN	1	14	19200	EVEN	1																																																																				
7	4800	ODD	1	15	19200	ODD	1																																																																				
40019	Password	R	<p>This address is used to set and reset the password.</p> <p>Password protection off = 1            Password protection on = 0</p>																																																																								
		W	<p>When active password protection, write first the old password and then the new password.</p> <p>Password protection off = 0000            New Password = 1234 (Valid range of the password is 0000-9999)</p>																																																																								
40021	--	--	--																																																																								
40023	--	--	--																																																																								
40025	--	--	--																																																																								
40027	Simulation output O/P1	R/W	This address is used to set the simulation output O/P1 to 10% of output by writing 1000 and 100% of output by writing 10000.																																																																								
40029	Simulation output O/P2	R/W	This address is used to set the simulation output O/P2 to 10% of output by writing 1000 and 100% of output by writing 10000.																																																																								
40031	Analog O/P1	R/W	<p>This address is used to set the Analog O/P1 as Voltage/Current.</p> <p>Voltage = 1            Current = 2</p>																																																																								
40033	Output para Select	R/W	<p>This address is used to set the Transducer type as :</p> <table border="1"> <thead> <tr> <th>Value</th> <th>Description</th> </tr> </thead> <tbody> <tr> <td>1</td> <td>Active Power</td> </tr> <tr> <td>2</td> <td>Apparent Power</td> </tr> <tr> <td>3</td> <td>Reactive Power</td> </tr> <tr> <td>4</td> <td>Power Factor</td> </tr> <tr> <td>5</td> <td>Phase Angle</td> </tr> </tbody> </table>	Value	Description	1	Active Power	2	Apparent Power	3	Reactive Power	4	Power Factor	5	Phase Angle																																																												
Value	Description																																																																										
1	Active Power																																																																										
2	Apparent Power																																																																										
3	Reactive Power																																																																										
4	Power Factor																																																																										
5	Phase Angle																																																																										
40035	Analog O/P 2	R/W	<p>This address is used to set the Analog O/P2 as Voltage/Current.</p> <p>Voltage = 1            Current = 2</p>																																																																								
40041	Diagnosis Mode	R/W	<p>This address is used to set transducer into the Diagonosis or Normal mode.</p> <p>Normal mode = 0 Diagnosis mode =1.            Note: After power ON / OFF Transducer goes to normal mode</p>																																																																								